



**QUALITYFRY**  
AUTOMATIC SMART COOKING

---



---

**WE REVOLUTIONISE THE PROFESSIONAL KITCHEN**

**GENERAL CATALOGUE**

# REVOLUTIONISING THE KITCHEN OF THE FUTURE

At QualityFry we contribute to the advancement of the professional kitchen through the design and manufacture of **automatic frying technology that with no fume and no odour**. Through our experience as an innovative company, we offer quality frying that is safe, healthy and sustainable.



## COMMITMENT TO QUALITY

Our commitment to quality has led us to obtain certifications and awards that recognise us as a company of innovation, research and development.



## INNOVATION IS OUR DNA

At QualityFry we believe in efficient professional cooking through innovation. That is why our designs have made us pioneers in energy savings and operator safety through the Built In fume extraction system.

## GUARANTEED QUALITY

Our innovative, closed, vertical frying module fries with no light and with virtually no oxygen. In this way, we minimise heat loss and ensure a constant oil temperature during frying, guaranteeing exceptional quality.



## PERSONALISED SERVICE

Our aim is focused on the real needs of our customers: to provide them with the best cooking solutions and support them through exceptional expertise and our extensive network of distributors and service partners around the world.

## ECOFRY SYSTEM

Our EcoFry System, based on constant innovation and development, minimises the ecological footprint and improves energy efficiency.

## ALWAYS BY YOUR SIDE

### Wherever you are

We are a global company. We have our headquarters and production centre in Spain. In addition, we have a wide network of distributors and technical service in all continents.



# ECOFRY TECHNOLOGY

A new fryer concept like no other on the market.

Energy efficient.

A CLOSED  
MACHINE THAT  
FRIES VERTICALLY

FRYING PROCESS  
THAT DRIES AND  
EVAPORATES THE OIL

NO SMOKE  
AND NO ODOUR  
TECHNOLOGY

## VERSATILITY IN THE PREPARATION OF DIFFERENT FOODS

Cooks any type of product at its optimum point, whether frozen or fresh, sweet or savoury.



1

### FRYING

Sealed frying chamber, which does not mix flavours or odours and also achieves faster temperature recovery.

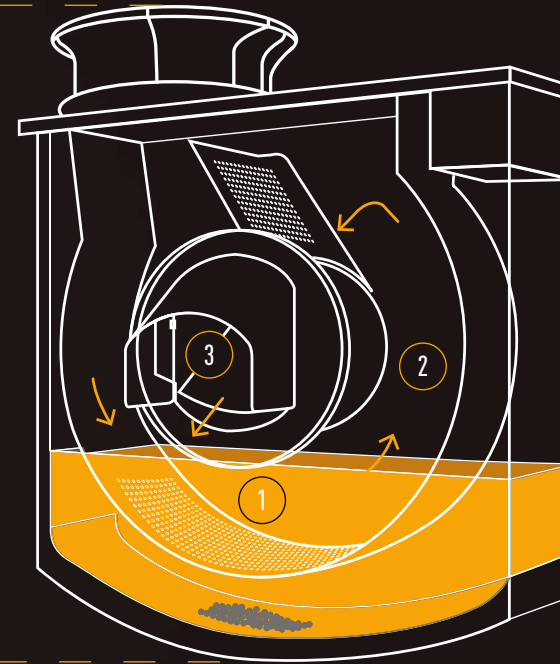

2

### DRYING

A process that minimises oil waste, resulting in healthier products.

3

### EXTRACTION

Automatic product management

A TECHNOLOGY  
THAT MAKES US  
UNIQUE

**-24%**  
ENERGY  
CONSUMPTION

Its innovative closed and vertical frying module minimises heat loss, keeping the oil at an optimal temperature and speeding up frying time, providing energy savings over a conventional fryer.

**-37%**  
OIL  
CONSUMPTION

Its filter system creates a frying and drying process that extracts water, volatilising the solid particles of the cooked food. Lower oil consumption doesn't just affect oil savings, but it also has a great impact on the amount of fats absorbed by the product, leading to frying that is healthier and better quality.

**-27%**  
FRY  
TIME

Its filter system helps minimise frying time thanks to its high-efficiency technology.





# MODELS

## iQ 600 - iQ 610

### GOURMET

Speed and efficiency



COOK 2 PRODUCTS AT THE SAME TIME  
WHILE KEEPING 1 ON STANDBY

FRY PORTIONS UP TO  
250g for individuals portions    600g for large portions

NO SMOKE AND NO ODOUR  
TECHNOLOGY

### LOAD AND FRY

Suitable for in-between portion sizes where loading and frying is most practical.  
Fry two portions at a time, while a third is waiting in the entry hopper.

### SPEED UP YOUR BUSINESS

Digitalise and automate the frying production area to maximise its profitability and ensure optimal quality levels.

### SINGLE-PHASE ELECTRIC SPECIFICATIONS

	iQ 600 BASIC GOURMET	iQ 610 GOURMET
Voltage	208-230 VAC	208-230 VAC
Frequency	50/60 Hz	50/60 Hz
Power	16 amp	20 amp
Socket 1*	☺ IEC 309, 16 amp 3-pin socket	☺ IEC 309, 32 amp 3-pin socket
Socket 2*	☺ 16A Schuko plug	☑ 25A 1P+N +T 230V
Maximum input power	3,500 Watts	4,600 Watts

\*Recommended sockets



### TECHNICAL SPECIFICATIONS

Oil capacity	5,5 litres	
Loading hoppers	1 zone + 2 cooking	250 - 600g ( max. 2.5 kg )
Production per hour	Up to 21 kg**	
Display	5" touchscreen	8 programmable times
Upper part (for loading)	12"	300 mm
Sides	6"	150 mm

\*\*Production per hour is based on 6x6 mm quick-fry potatoes for the model iQ610 Gourmet

### DIMENSIONS

Height	30.3"	770 mm
Width	26.4"	670 mm
Depth	19.7"	500 mm
Weight	143 lbs	65 kg
Packaged weight	178 lbs	81 kg
Packaged dimensions	1230 x 800 x 600 mm (height x width x depth)	

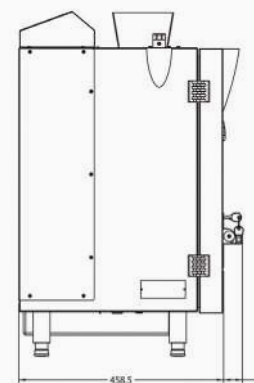
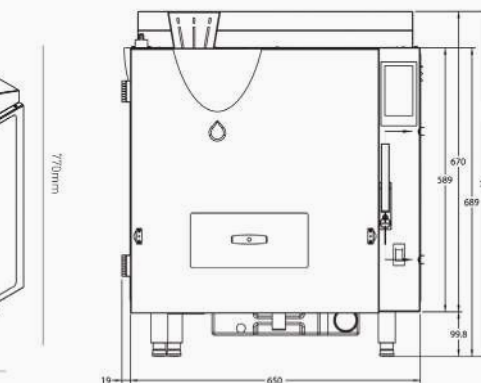
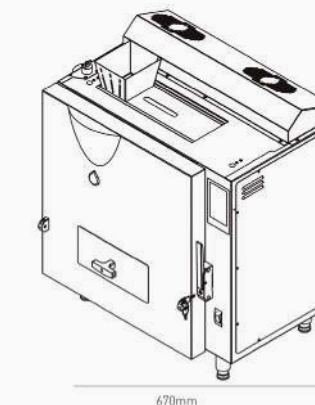

### SMART AND DIGITAL COOKING

- 8 programmable times
- Easy and intuitive to use
- 5" touch display
- Provides the user with real-time information



# MODELS

## iQ 620 - iQ 630

### CARROUSEL

Automation and versatility



COOK 2 PRODUCTS AT THE SAME TIME  
WHILE KEEPING 4 ON STANDBY

FRY PORTIONS OF UP TO  
250g for individuals portions    600g for large portions

PLUG & PLAY, COMPACT SIZE  
AND SIMPLE INSTALLATION

### AUTONOMOUS AND AUTOMATIC

Able to cook autonomously and automatically, one operator controls the entire process. All you have to do is press a button and the product is ready to serve.

### MULTIPLE PRODUCT MANAGEMENT

Its innovative design allows you to programme up to 6 portions at a time, 2 in the frying chamber and 4 in the carousel hopper, with no need to reload.

### SINGLE-PHASE ELECTRIC SPECIFICATIONS

	iQ 620 BASIC CARROUSEL	iQ 630 CARROUSEL
Voltage	208-230 VAC	208-230 VAC
Frequency	50/60 Hz	50/60 Hz
Power	16 amp	20 amp
Socket 1*	☺ IEC 309, 16 amp 3-pin socket	☺ IEC 309, 32 amp 3-pin socket
Socket 2*	☺ 16A Schuko plug	☑ 25A 1P+N +T 230V
Maximum input power	3,500 Watts	4,600 Watts

\*Recommended sockets

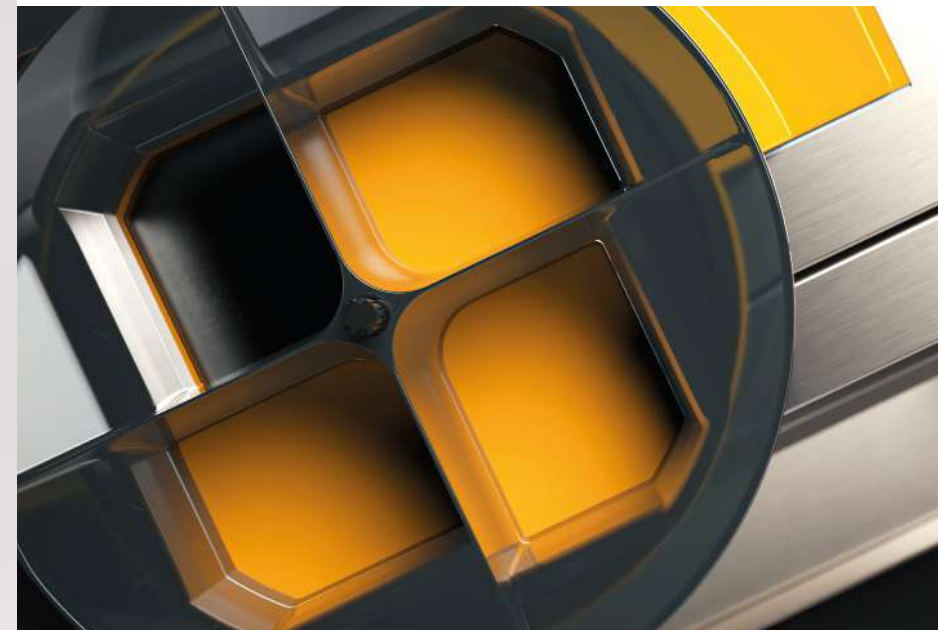

### TECHNICAL SPECIFICATIONS

Oil capacity	5,5 litres	
Loading hoppers	4 zone + 2 cooking	250 - 600 g (max. 2.5 kg)
Production per hour	Up to 21 kg**	
Display	5" touchscreen	8 programmable times
Upper part (for loading)	12"	300 mm
Sides	6"	150 mm

\*\*Production per hour is based on 6x6 mm quick-fry potatoes for the model iQ630 Carrousel

### DIMENSIONS

Height	33.7"	856 mm
Width	26.4"	670 mm
Depth	17.9"	457 mm
Depth with tray	24.8"	630 mm
Weight	155 lbs	70 kg
Packaged weight	190 lbs	86 kg
Packaged dimensions	1230 x 800 x 600 mm	(height x width x depth)

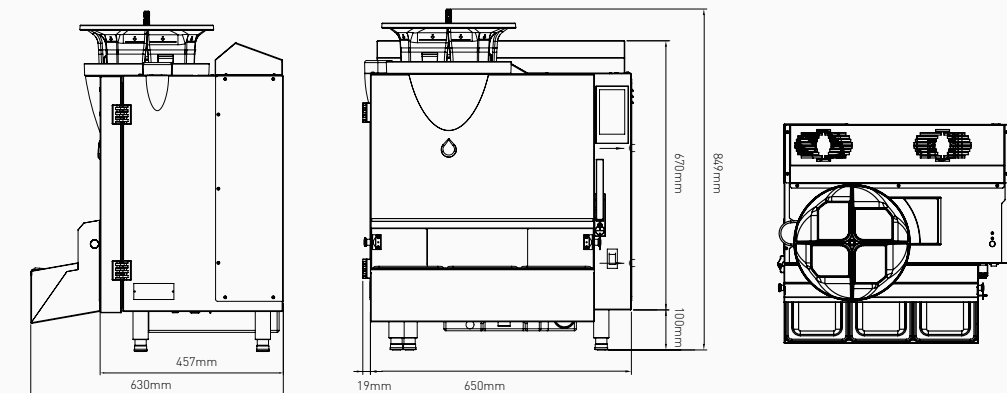

### SMART AND DIGITAL COOKING

- 8 programmable times
- Easy and intuitive to use
- 5" touch display
- Provides the user with real-time information





# MODEL iQ 640

## FES CARROUSEL

### Safety

The Fire Extinguishing System (FES) is a pre-engineering system that is designed and built under the "UNE 23510:2017 Fire extinguishing systems in commercial kitchens. Design and test requirements" standard.

### FIRE DETECTION AND DISCHARGE START

4s

### TIME TO EXTINGUISH FIRE

1s

### TOTAL DISCHARGE TIME

28s



### REFERENCE STANDARDS

The FES has been subject to testing under the following reference standards:  
CTE - Código Técnico de la Edificación (Spanish Technical Building Code). UNE 23510 2017 Fire extinguishing systems in commercial kitchens - Design and test requirements. EN 15351 2015. EN 16282 7 Equipment for commercial kitchens - Part 7: Installation and use of fixed fire suppression systems. UL 300 Fire Testing of Fire Extinguishing Systems for Protection of Commercial Cooking Equipment.

### FIRE EXTINGUISHING SYSTEM (FES)

There is no need to include other external temperature control equipment or systems.

There is no need to include any other extinction systems other than those that are compulsory for your business or space.

## ADVANTAGES OF THE SYSTEM

- Its active compounds are water 100% biodegradable additives that are toxic-free and environmentally friendly.
- In addition to being the optimal system for extinguishing class F fires, it is also fully certified for class A and B fires, meaning that it can be used instead of powder extinguishers in most cases.
- Once unloaded, the product doesn't deteriorate any equipment that it comes into contact with.
- As it doesn't use powder, it doesn't lead to low visibility in closed spaces.
- Unlike CO2 and powder extinguishers, there's no risk of asphyxiation or difficulty breathing when used in a closed space.

## SINGLE-PHASE ELECTRIC SPECIFICATIONS

Voltage	208-230 VAC
Frequency	50/60 Hz
Power	20 amp
Socket 1*	☺ IEC 309, 32 amp 3-pin socket
Socket 2*	☑ 25A 1P+N +T 230V
Maximum input power	4,600 Watts

\*Recommended sockets

## TECHNICAL SPECIFICATIONS

Oil capacity	5,5 litres
Loading hoppers	4 zones + 2 cooking 250 - 600 g (max. 2.5 kg)
Production per hour	Up to 21 kg**
Display	5" touchscreen 8 programmable times
Upper part (for loading)	12" 300 mm
Sides	6" 150 mm

\*\*Production per hour is based on 6x6 mm quick-fry potatoes for the model iQ640 FES Carrousel

## DIMENSIONS

Height	33.7"	856 mm
Width	28.1"	715 mm
Depth	17.9"	457 mm
Depth with tray	24.8"	630 mm
Weight	165 lbs	75 kg
Packaged weight	198 lbs	90 kg
Packaged dimensions	1230 x 800 x 600 mm	(height x width x depth)

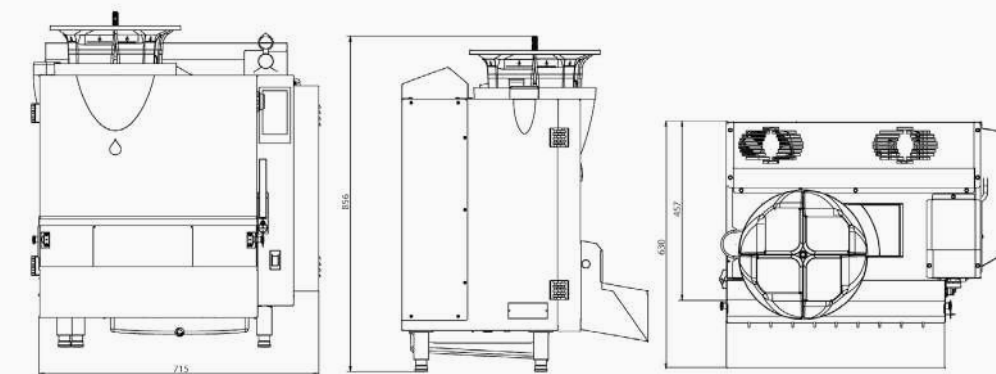

# MODEL iQ 1000

**CARROUSEL**  
High-production

COOKS 2 PRODUCTS AT A TIME, WHILE  
KEEPING 4 ON STANDBY

FRY PORTIONS OF UP TO  
500g for individuals portions 800g for large portions

ECOFRY TECHNOLOGY

## COMPACT AND EFFICIENT

Its compact, efficient and clean system finishes products in record time and with a perfect finish.



## PROCESS AUTOMATION AND STANDARDISATION

Designed to offer freshly made food of the highest quality in a way that is completely autonomous and functional.

## THREE-PHASE ELECTRIC SPECIFICATIONS

Voltage	380 VAC
Frequency	50/60 Hz
Power	16 amp
Socket*	IEC Three-phase, 16 amp 3-pin +N +E socket
Maximum input power	7,800 Watts

\*Recommended sockets



## TECHNICAL SPECIFICATIONS

Oil capacity	10 litres
Loading hoppers	4 zones + 2 cooking 500 - 800 g
Production per hour	Up to 33 kg**
Display	10.1" touchscreen 21 programmable times
Upper part (to allow loading)	12" 300 mm
Sides	6" 150 mm

\*\*Production per hour is based on 6x6 mm quick-fry potatoes for the model iQ 1000 Carrousel



## DIMENSIONS



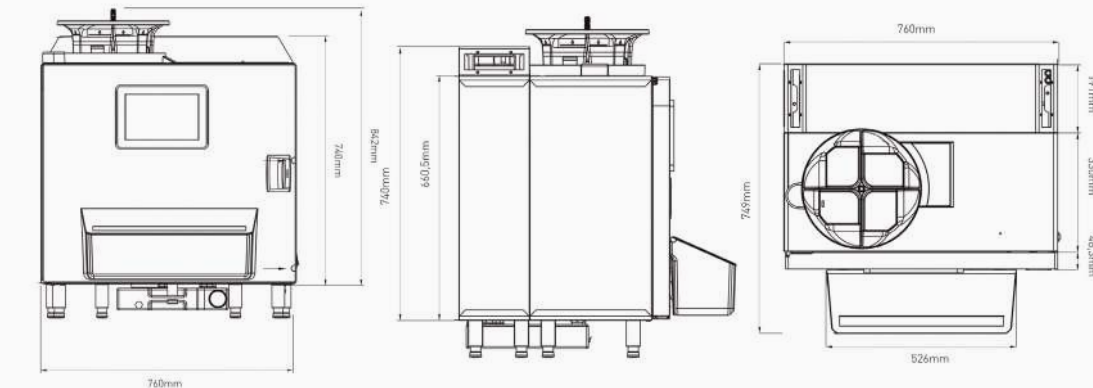



Height	37.0"	942 mm
Width	29.9"	760 mm
Depth	22.4"	570 mm
Depth with tray	29.5"	750 mm
Weight	210 lbs	95 kg
Packaged weight	231 lbs	105 kg
Packaged dimensions	1250 x 900 x 720 mm	(height x width x depth)



## SMART AND DIGITAL COOKING

- 21 programmable times
- 10.1" touch screen
- UX-friendly
- Enables you to edit and personalise the images, times and text
- Provides the user with real-time information



CHARACTERISTICS			MODELS							
			<b>iQ 600 BASIC GOURMET</b>	<b>iQ 610 GOURMET</b>	<b>iQ 620 BASIC CARROUSEL</b>	<b>iQ 630 CARROUSEL</b>	<b>iQ 640 FES CARROUSEL</b>	<b>iQ 1000 CARROUSEL</b>		
<b>DIMENSIONS (HEIGHT X WIDTH X DEPTH)</b>	Without packaging	Measurements	770 X 670 X 500 mm	770 X 670 X 500 mm	856 x 670 x 630 mm	856 x 670 x 630 mm	856 x 715 x 630 mm	942 x 760 x 750 mm		
		Weight	65 kg	65 kg	70 kg	70 kg	75 kg	95 kg		
	With packaging	Measurements	1230 x 800 x 600 mm	1230 x 800 x 600 mm	1230 x 800 x 600 mm	1230 x 800 x 600 mm	1230 x 800 x 600 mm	1250 x 900 x 720 mm		
		Weight	81 kg	81 kg	86 kg	86 kg	90 kg	105 kg		
<b>OIL CAPACITY</b>	5,5 Litres		✓	✓	✓	✓	✓	—		
	10 Litres		—	—	—	—	—	✓		
<b>LOADING HOPPER</b>	Capacity	Small portions	250 g	250 g	250 g	250 g	250 g	500 g		
		Large portions	600 g	600 g	600 g	600 g	600 g	800 g		
	Continuous production		2 cooking + 1 on standby	2 cooking + 1 on standby	2 cooking + 4 on standby	2 cooking + 4 on standby	2 cooking + 4 on standby	2 cooking + 4 on standby		
	Production per hour*		10 kg	13 kg	10 kg	13 kg	13 kg	20 kg		
	Production per hour**		16 kg	21 kg	16 kg	21 kg	21 kg	33 kg		
<b>ELECTRIC SPECIFICATIONS</b>	Voltage (VAC)	230 V	✓	✓	✓	✓	✓	—		
		380 V	—	—	—	—	—	✓		
	Power (W)	3,500 W	✓	—	✓	—	—	—		
		4,600 W	—	✓	—	✓	✓	—		
		7,800 W	—	—	—	—	—	✓		
	Current (amp)	16 Amp	✓	—	✓	—	—	✓		
		20 Amp	—	✓	—	✓	✓	—		
	Socket	Single-phase	✓	✓	✓	✓	✓	—		
Three-phase		—	—	—	—	—	✓			
<b>INTELLIGENT DISPLAY</b>	Screen size	5"	✓	✓	✓	✓	✓	—		
		10.1"	—	—	—	—	—	✓		
	Programmable times	8	✓	✓	✓	✓	✓	—		
		21	—	—	—	—	—	✓		
<b>ELIMINATES ODOURS FROM THE FRYING PROCESS</b>			✓	✓	✓	✓	✓	✓		
<b>ELIMINATES STEAM FROM THE FRYING PROCESS</b>			✓	✓	✓	✓	✓	✓		
<b>WITHOUT MIXING FOOD FLAVOURS</b>			✓	✓	✓	✓	✓	✓		
<b>SAFETY</b>	Oil level probe (cold)		✓	✓	✓	✓	✓	✓		
	Oil level probe (hot)		✓	✓	✓	✓	✓	✓		
	Fire Extinguishing System (FES)		—	—	—	—	✓	—		

\* Production per hour is based on 6x6mm frozen potatoes.  
\*\* Production per hour is based on 6x6 mm quick-fry potatoes.  
The type of oil, its use, the cooking temperature and the starting temperature of the product will affect cooking times and production per hour.





# SOLUTIONS ADAPTED TO EACH SECTOR





# NO SMOKE AND NO ODOUR PROFESSIONAL FRYERS

Easily customisable to your space, production or autonomy.



## HORECA

QualityFry is much more than a professional fryer for the foodservice industry. It is an automatic and smart machine that marks a before and after in the professional kitchen of any restaurant, cafeteria or bar. And it does so for many reasons.



## HOTELS

The world of hotel foodservice needs to make its business profitable now more than ever and QualityFry is the perfect solution to do so. Thanks to its automatic and smart system, this professional fryer does not require additional or specialised staff and offers endless possibilities, both in the urban and resort hotel sector.



## PETROL STATIONS

QualityFry is a professional cooking system, unique in the market, which offers enormous possibilities for making service station visits as profitable as possible. Boosting impulse purchases, increasing the average spend and facilitating the new consumption trends based on take-away.



## BAKERY COFFEE

QualityFry is much more than a professional fryer. It is a key element when implementing new kitchen services in your business, such as take-away or delivery. But QualityFry also allows you to increase your kitchen hours and cover off-peak hours without the need to hire extra or specialised staff. Because this machine is fully automatic and smart, and can be operated while serving customers.



## RETAIL

The world of retail welcomes QualityFry. A unique professional fryer which, thanks to its exclusive built-in technology, fries food vertically without releasing any fumes or odours. And without polluting the environment.



## CATERING BUSINESS

QualityFry is always the right choice when it comes to company canteens, schools, universities, museums, catering for events, etc. Above all because of its versatility. Thanks to its exclusive cooking system, this machine is capable of frying, sealing and enhancing all types of food. Whether sweet or savoury. Fresh or frozen. And it does so while improving their quality because QualityFry cooks with less fat and at the same time guarantees a longer-lasting crispiness.



## CONVENIENCE STORES

You don't need to own a restaurant to benefit from all the advantages that QualityFry offers. Because this professional fryer offers new business opportunities, allowing you to implement a delivery or take-away service in a small space.



## OTHER SPACES

Cinemas, theatres, stadiums, theme parks, food trucks, cruise ships... Wherever there's leisure, free time and fun, there's a place for QualityFry. Because this professional fryer is, among other things, small and handy. And because it is single-phase, it is very easy to install. But its advantages go far beyond that.

## WHAT CAN IT COOK?

Thanks to QualityFry's advanced technology, we achieve the perfect finish and flavour when frying all kinds of food products, whether fresh or frozen, sweet or savoury, all using the same oil and without mixing aromas or flavours. With QualityFry, the end product is food products that are visibly more attractive, golden and crunchy. A quality that only our products can offer.

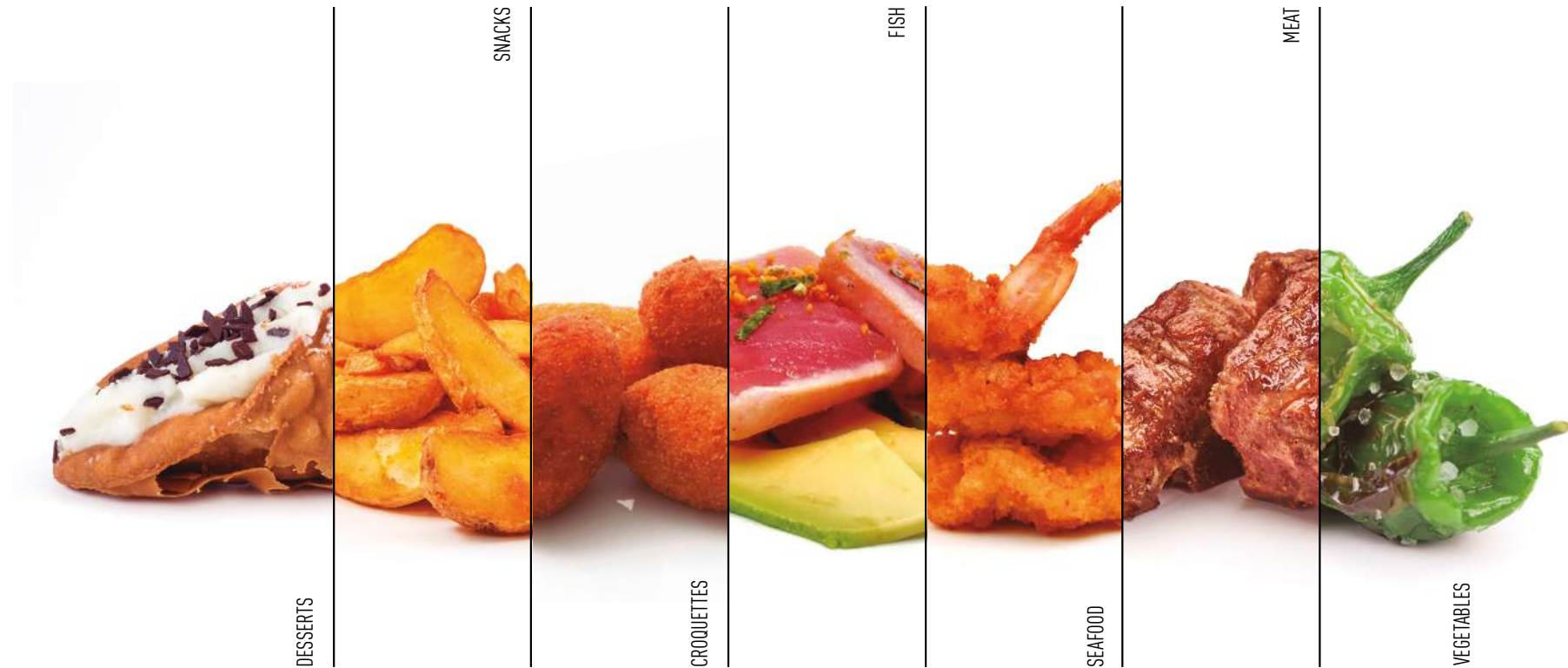





**QUALITYFRY**  
AUTOMATIC SMART COOKING

---

C/ Albasanz, 12, Planta 1 - 28037 Madrid - Spain

Tel: +34 913 759 567 | [info@qualityfry.com](mailto:info@qualityfry.com)